

# ASM3P2590A

## Product Preview

# Low Power Peak EMI Reducing Solution

### Description

The ASM3P2590A is a versatile spread spectrum frequency modulator designed specifically for a wide range of clock frequencies. The ASM3P2590A reduces electromagnetic interference (EMI) at the clock source, allowing system wide reduction of EMI of all clock dependent signals. The ASM3P2590A allows significant system cost savings by reducing the number of circuit board layers, ferrite beads and shielding that are traditionally required to pass EMI regulations.

The ASM3P2590A uses the most efficient and optimized modulation profile approved by the FCC and is implemented by using a proprietary all digital method.

The ASM3P2590A modulates the output of a single PLL in order to “spread” the bandwidth of a synthesized clock, and more importantly, decreases the peak amplitudes of its harmonics. This results in significantly lower system EMI compared to the typical narrow band signal produced by oscillators and most frequency generators. Lowering EMI by increasing a signal’s bandwidth is called ‘spread spectrum clock generation.’

### Applications

The ASM3P2590A is targeted towards all portable devices with very low power requirements like MP3 players, MFP, LCD Panel Module and digital still cameras.

### Features

- Generates a 1X Low EMI Optimized Clock Signal at the Output
- Integrated Loop Filter Components
- Operates with a 3.3 / 2.5 V Supply
- Operating Current less than 5 mA
- Low Power CMOS Design
- Input Frequency Range:
  - 60 MHz to 120 MHz for 2.5 V
  - 60 MHz to 120 MHz for 3.3 V
- Frequency Deviation:  $\pm 0.75\%$  (Typ) @ 85 MHz Output Frequency
- Available in 6-pin TSOT-23 Package
- These Devices are Pb-Free, Halogen Free/BFR Free and are RoHS Compliant

This document contains information on a product under development. ON Semiconductor reserves the right to change or discontinue this product without notice.



ON Semiconductor®

<http://onsemi.com>



TSOT-6  
O SUFFIX  
CASE 419AF

### PIN CONFIGURATION

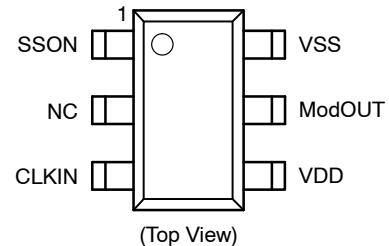

### KEY SPECIFICATIONS

Description	Specification
Supply Voltages	VDD = 3.3 V / 2.5 V
Cycle-to-Cycle Jitter	360 pS (Typ)
Output Duty Cycle	45/55%
Modulation Rate Equation	$F_{IN}/2560$
Frequency Deviation	$\pm 0.75\%$ (Typ) @ 85 MHz Output

### ORDERING INFORMATION

See detailed ordering and shipping information in the package dimensions section on page 6 of this data sheet.

# ASM3P2590A

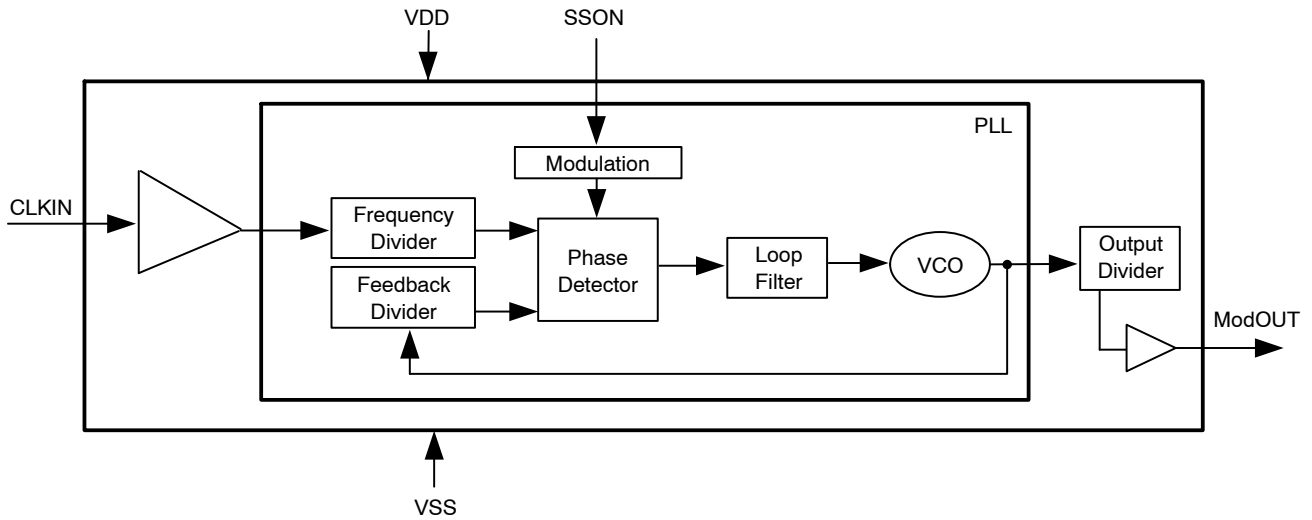

Figure 1. Block Diagram

Table 1. PIN DESCRIPTION

Pin#	Pin Name	Type	Description
1	SSON	I	When SSON is HIGH, the spread spectrum is enabled and when LOW, it turns off the spread spectrum. Connect the pin to ground when Spread Spectrum feature is not required.
2	NC	-	No Connect.
3	CLKIN	I	Clock Input.
4	VDD	P	Power supply for the entire chip.
5	ModOUT	O	Spread spectrum clock output.
6	VSS	P	Ground connection.

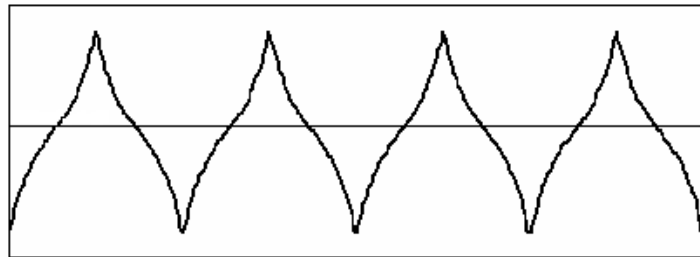

Figure 2. Modulation Profile

Table 2. SPECIFICATIONS

Description		Specification
Frequency Range	For 2.5 V Supply	60 MHz < CLKIN < 120 MHz
	For 3.3 V Supply	60 MHz < CLKIN < 120 MHz
Modulation Equation		$F_{IN}/2560$
Frequency Deviation		$\pm 0.75\%$ (Typ) @ 85 MHz Output

# ASM3P2590A

**Table 3. ABSOLUTE MAXIMUM RATINGS**

Symbol	Parameter	Rating	Unit
VDD, VIN	Voltage on any pin with respect to Ground	-0.5 to +4.6	V
T <sub>STG</sub>	Storage temperature	-65 to +125	°C
T <sub>A</sub>	Operating temperature	-40 to +85	°C
T <sub>s</sub>	Max. Soldering Temperature (10 sec)	260	°C
T <sub>J</sub>	Junction Temperature	150	°C
T <sub>DV</sub>	Static Discharge Voltage (As per JEDEC STD22- A114-B)	2	KV

Stresses exceeding Maximum Ratings may damage the device. Maximum Ratings are stress ratings only. Functional operation above the Recommended Operating Conditions is not implied. Extended exposure to stresses above the Recommended Operating Conditions may affect device reliability.

**Table 4. DC ELECTRICAL CHARACTERISTICS FOR 2.5 V SUPPLY**

Symbol	Parameter	Min	Typ	Max	Unit
V <sub>IL</sub>	Input low voltage	VSS-0.3	-	0.8	V
V <sub>IH</sub>	Input high voltage	2.0	-	VDD+0.3	V
I <sub>IL</sub>	Input low current	-	-	-35	μA
I <sub>IH</sub>	Input high current	-	-	35	μA
V <sub>OL</sub>	Output low voltage (VDD = 2.5 V, I <sub>OL</sub> = 8 mA)	-	-	0.6	V
V <sub>OH</sub>	Output high voltage (VDD = 2.5 V, I <sub>OH</sub> = 8 mA)	1.8	-	-	V
I <sub>DD</sub>	Static supply current (Note 1)	-	1.8	-	mA
I <sub>CC</sub>	Dynamic supply current (2.5 V, 85 MHz and no load)	-	4.0	-	mA
VDD	Operating voltage	2.375	2.5	2.625	V
t <sub>ON</sub>	Power-up time (first locked cycle after power-up)	-	-	5	mS
Z <sub>OUT</sub>	Output impedance	-	50	-	Ω

1. CLKIN pin is pulled low.

**Table 5. AC ELECTRICAL CHARACTERISTICS FOR 2.5 V SUPPLY**

Symbol	Parameter	Min	Typ	Max	Unit	
CLKIN	Input frequency	60	-	120	MHz	
ModOUT	Output frequency	60	-	120	MHz	
f <sub>d</sub>	Frequency Deviation	Input Frequency = 60 MHz	-	±0.85	-	%
		Input Frequency = 120 MHz	-	±0.60	-	
t <sub>LH</sub> (Note 2)	Output rise time (measured from 0.7 V to 1.7 V)	0.7	1.8	2.6	nS	
t <sub>HL</sub> (Note 2)	Output fall time (measured from 1.7 V to 0.7 V)	0.4	0.9	1.1	nS	
t <sub>JC</sub>	Jitter (Cycle-to-cycle)	-	360	-	pS	
t <sub>D</sub>	Output duty cycle	45	50	55	%	

2. t<sub>LH</sub> and t<sub>HL</sub> are measured into a capacitive load of 15 pF.

# ASM3P2590A

**Table 6. DC ELECTRICAL CHARACTERISTICS FOR 3.3 V SUPPLY**

Symbol	Parameter	Min	Typ	Max	Unit
V <sub>IL</sub>	Input low voltage	VSS-0.3	–	0.8	V
V <sub>IH</sub>	Input high voltage	2.0	–	VDD+0.3	V
I <sub>IL</sub>	Input low current	–	–	-35	μA
I <sub>IH</sub>	Input high current	–	–	35	μA
V <sub>OL</sub>	Output low voltage (VDD = 3.3 V, I <sub>OL</sub> = 8 mA)	–	–	0.4	V
V <sub>OH</sub>	Output high voltage (VDD = 3.3 V, I <sub>OH</sub> = 8 mA)	2.5	–	–	V
I <sub>DD</sub>	Static supply current (Note 3)	–	2.2	–	mA
I <sub>CC</sub>	Dynamic supply current (3.3 V, 85 MHz and no load)	–	4.5	–	mA
VDD	Operating voltage	3.0	3.3	3.6	V
t <sub>ON</sub>	Power-up time (first locked cycle after power-up)	–	–	5	mS
Z <sub>OUT</sub>	Output impedance	–	45	–	Ω

3. CLKIN pin is pulled low.

**Table 7. AC ELECTRICAL CHARACTERISTICS FOR 3.3 V SUPPLY**

Symbol	Parameter	Min	Typ	Max	Unit	
CLKIN	Input frequency	60	–	120	MHz	
ModOUT	Output frequency	60	–	120	MHz	
f <sub>d</sub>	Frequency Deviation	Input Frequency = 60 MHz	–	±0.85	–	%
		Input Frequency = 120 MHz	–	±0.60	–	
t <sub>LH</sub> (Note 4)	Output rise time (measured from 0.8 to 2.0 V)	0.5	1.2	1.8	nS	
t <sub>HL</sub> (Note 4)	Output fall time (measured at 2.0 V to 0.8 V)	0.3	0.8	1.1	nS	
t <sub>JC</sub>	Jitter (cycle-to-cycle)	–	360	–	pS	
t <sub>D</sub>	Output duty cycle	45	50	55	%	

4. t<sub>LH</sub> and t<sub>HL</sub> are measured into a capacitive load of 15 pF.

# ASM3P2590A

## PACKAGE DIMENSIONS

TSOT-23, 6 LEAD  
CASE 419AF-01  
ISSUE O

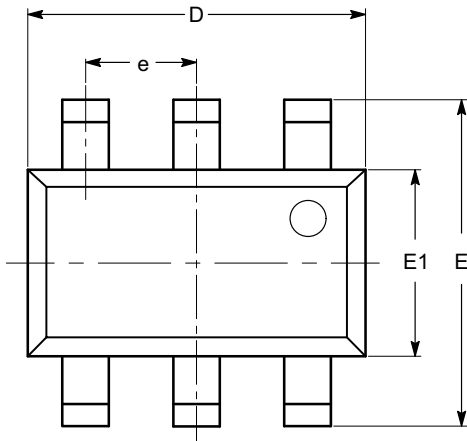

TOP VIEW

SYMBOL	MIN	NOM	MAX
A			1.00
A1	0.01	0.05	0.10
A2	0.80	0.87	0.90
b	0.30		0.45
c	0.12	0.15	0.20
D	2.90 BSC		
E	2.80 BSC		
E1	1.60 BSC		
e	0.95 TYP		
L	0.30	0.40	0.50
L1	0.60 REF		
L2	0.25 BSC		
$\theta$	0°		8°

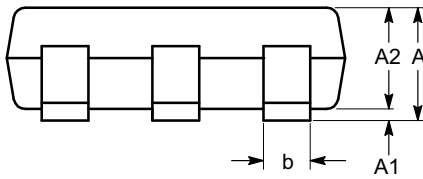

SIDE VIEW

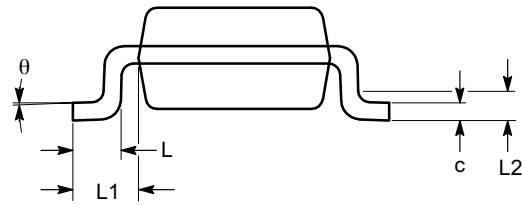

END VIEW

### Notes:

- (1) All dimensions are in millimeters. Angles in degrees.
- (2) Complies with JEDEC MO-193.

# ASM3P2590A

**Table 8. ORDERING INFORMATION**

Part Number	Marking	Package Type	Temperature
P3P2590AF-06OR	Y4	6-Pin TSOT-23, TAPE & REEL, Pb Free	Commercial
ASM3P2590AG-06-OR	Y3	6-Pin TSOT-23, TAPE & REEL, Green	Commercial
ASM3I2590AF-06-OR	Y5	6-Pin TSOT-23, TAPE & REEL, Pb Free	Industrial
ASM3I2590AG-06-OR	Y6	6-Pin TSOT-23, TAPE & REEL, Green	Industrial

**ON Semiconductor** and  are registered trademarks of Semiconductor Components Industries, LLC (SCILLC). SCILLC reserves the right to make changes without further notice to any products herein. SCILLC makes no warranty, representation or guarantee regarding the suitability of its products for any particular purpose, nor does SCILLC assume any liability arising out of the application or use of any product or circuit, and specifically disclaims any and all liability, including without limitation special, consequential or incidental damages. "Typical" parameters which may be provided in SCILLC data sheets and/or specifications can and do vary in different applications and actual performance may vary over time. All operating parameters, including "Typicals" must be validated for each customer application by customer's technical experts. SCILLC does not convey any license under its patent rights nor the rights of others. SCILLC products are not designed, intended, or authorized for use as components in systems intended for surgical implant into the body, or other applications intended to support or sustain life, or for any other application in which the failure of the SCILLC product could create a situation where personal injury or death may occur. Should Buyer purchase or use SCILLC products for any such unintended or unauthorized application, Buyer shall indemnify and hold SCILLC and its officers, employees, subsidiaries, affiliates, and distributors harmless against all claims, costs, damages, and expenses, and reasonable attorney fees arising out of, directly or indirectly, any claim of personal injury or death associated with such unintended or unauthorized use, even if such claim alleges that SCILLC was negligent regarding the design or manufacture of the part. SCILLC is an Equal Opportunity/Affirmative Action Employer. This literature is subject to all applicable copyright laws and is not for resale in any manner.

## PUBLICATION ORDERING INFORMATION

### LITERATURE FULFILLMENT:

Literature Distribution Center for ON Semiconductor  
P.O. Box 5163, Denver, Colorado 80217 USA  
**Phone:** 303-675-2175 or 800-344-3860 Toll Free USA/Canada  
**Fax:** 303-675-2176 or 800-344-3867 Toll Free USA/Canada  
**Email:** [orderlit@onsemi.com](mailto:orderlit@onsemi.com)

**N. American Technical Support:** 800-282-9855 Toll Free  
USA/Canada  
**Europe, Middle East and Africa Technical Support:**  
Phone: 421 33 790 2910  
**Japan Customer Focus Center**  
Phone: 81-3-5773-3850

**ON Semiconductor Website:** [www.onsemi.com](http://www.onsemi.com)

**Order Literature:** <http://www.onsemi.com/orderlit>

For additional information, please contact your local Sales Representative